



KULP[®]
Packaging Machinery

Since 1984



Rinsing - Filling - Sealing - Capping - Labeling

ABOUT US

KULP® is a Turkish manufacturing company, established by Cunevt Dogrusoz in 1984 to remedy the need of packaging machinery, produces filling, capping and labeling machines. The first production has started with engineering and manufacturing filling machines, mixers tanks, cosmetics machinery and powder filling machines. Over the years, the company specialized into filling lines for liquid and viscous products, for the food, dairy, bakery, pharmaceutical, cosmetics, chemicals, and paint industries.

Today, more than 50 experts within a 1000 m² factory including production, sales, after-sales & management departments, work together to deliver high quality and long-life packaging equipment.

With references in more than 56 countries, KULP® continues growing through its authorized sales agents in Germany, Belgium, Greece, Australia, Italy, United Kingdom, Pakistan, India, Russia, Mexico, Colombia, and many up-coming reselling points in order to shorten the distance with the final customer.

Thanks to its rich spare parts stock, KULP® provides fast and efficient after sales services. The company also continuously presents new solutions to its customers and develops its machines each passing day.



Worldwide Sales

- Algeria
- Angola
- Argentina
- Australia
- Austria
- Azerbaijan
- Belgium
- Bulgaria
- Cameroon
- Canary Islands
- Colombia
- Cyprus
- Denmark
- D.R. of Congo
- Egypt
- Ethiopia
- Ghana
- Georgia
- Germany
- Greece
- Hungary
- Iceland
- India
- Indonesia
- Iran
- Iraq
- Italy
- Ivory Coast
- Jordan
- Kosovo
- Kuwait
- Kyrgyzstan
- Luxembourg
- Mexico
- Netherlands
- Norway
- Pakistan
- Panama
- Romania
- Russia
- Saudia Arabia
- Senegal
- South Africa
- Spain
- Sweden
- Switzerland
- Syria
- TR & Tobago
- Tunisia
- Turkmenistan
- UAE
- Uganda
- Ukraine
- UK
- USA
- Uzbekistan

PRODUCT CATEGORIES



1 SEMI AUTOMATIC FILLING MACHINES



2 ACCUMULATION TABLES



3 RINSERS



4 AUTOMATIC FILLING MACHINES

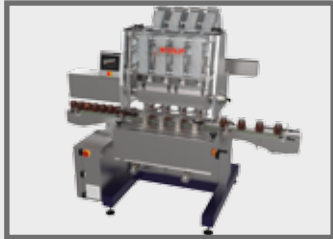

5 SEALING MACHINES



6 CAPPING MACHINES

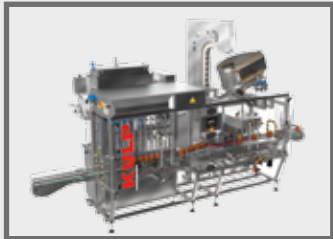

7 MONOBLOCK MACHINES



8 LABELING MACHINES



9 TRANSFER PUMPS



10 SPECIAL DESIGNS

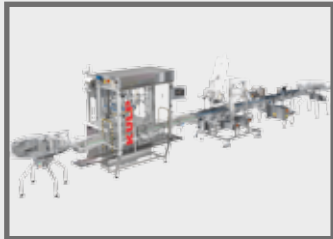

11 FILLING LINES

1

SEMI AUTOMATIC FILLING MACHINES D – VD SERIES

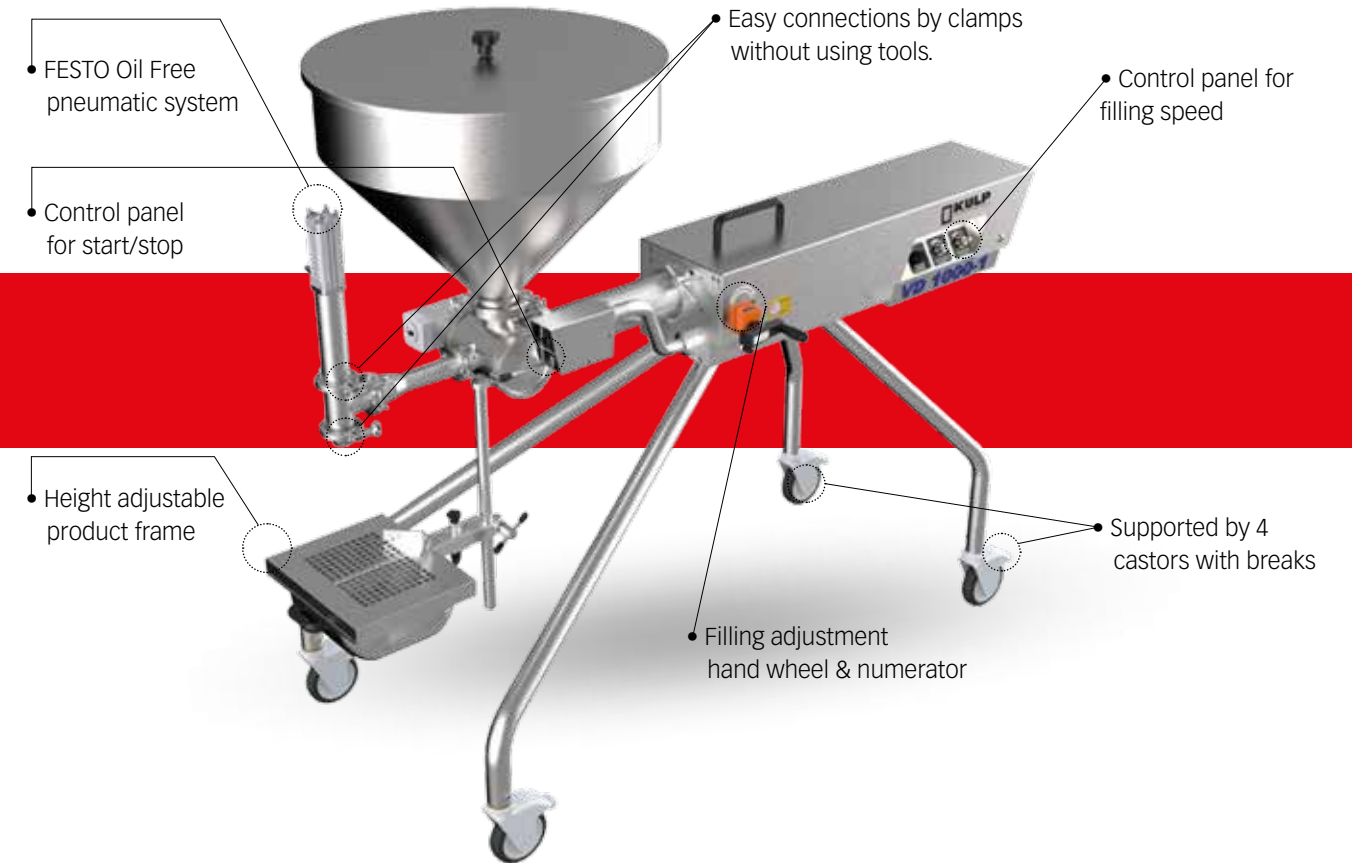

- Several products can be filled with the same machine
- Volumetric filling machines that works with FESTO pneumatic system
- Easy to adjust and record the filling range by the numerator and the hand wheels
- Several filling ranges available starting from 2ml up to 5000ml
- Interchangeable nozzles are available according to the products, either it's liquid, viscous or/and products with particles
- Filling accuracy: $\pm 1\%$
- Suitable for hot and cold filling processes
- High surface smoothness and argon arc welding technology prevents contamination

- The parts in contact with the product are in 316L stainless steel. The rest is in 304 stainless steel.
- The nozzle, main valve and the filling piston are designed for an easy-cleaning. They can be dismantled easily without using any tool
- The seals are manufactured from teflon, viton or polyethylene according to the product to be filled
- The machines stands on a stainless steel frame which is supported by 4 castors. It can be easily move to anywhere. Table top models are available
- Ideal for the food, dairy, cosmetic, pharmaceutical, chemical and bakery industries.

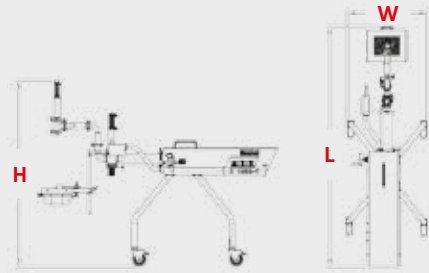

1

D SERIES

SEMI AUTOMATIC FILLING MACHINES

Filling Liquid and Semi Liquid Products

| | | D50 | D150 | D500 | D1000 | D2000 | D5000 |
|-------------------------------------------------|---|--------|----------|----------|------------|------------|------------|
| Filling Range (ml) (Min. - Max.) | | 5 - 50 | 15 - 150 | 50 - 500 | 100 - 1000 | 200 - 2000 | 500 - 5000 |
| Capacity (Packages/Hour) | | 1800 | 1500 | 1000 | 720 | 600 | 420 |
| Filling Range with Optional Cylinder (ml) | | 2 - 20 | 5 - 50 | 20 - 200 | 20 - 400 | 100 - 1000 | 150 - 1500 |
| Air Consumption (Lt./min.) | | 100 | 100 | 300 | 300 | 300 | 300 |
| Dimensions (mm) | W | 606 | 606 | 680 | 680 | 680 | 680 |
| | L | 1094 | 1178 | 1731 | 2000 | 2105 | 2328 |
| | H | 1288 | 1291 | 1538 | 1558 | 1558 | 1613 |
| Weight (kg) | | 50 | 50 | 110 | 120 | 130 | 150 |

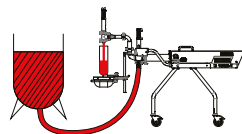

D1000

D50

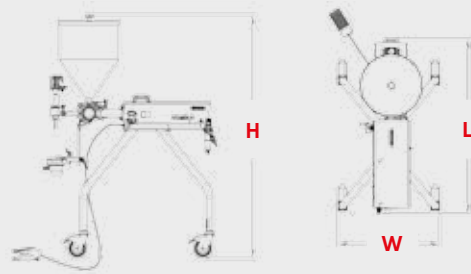

1

VD SERIES

SEMI AUTOMATIC FILLING MACHINES

Filling Liquid, Viscous and Products with Particles

| | | VD50 | VD150 | VD500 | VD1000 | VD2000 | VD5000 |
|-------------------------------------------------|---|--------|----------|----------|------------|------------|------------|
| Filling Range (ml) (Min - Max) | | 5 - 50 | 15 - 150 | 50 - 500 | 100 - 1000 | 200 - 2000 | 500 - 5000 |
| Capacity (Packages/Hour) | | 1800 | 1500 | 1000 | 720 | 600 | 420 |
| Filling Range with Optional Cylinder (ml) | | 2 - 20 | 5 - 50 | 20 - 200 | 20 - 400 | 100 - 1000 | 150 - 1500 |
| Hopper Volume (Lt.) | | 30 | 30 | 80 | 80 | 80 | 80 |
| Air Consumption (Lt./min.) | | 100 | 100 | 300 | 300 | 300 | 300 |
| Dimensions (mm) | W | 606 | 606 | 740 | 740 | 740 | 720 |
| | L | 1050 | 1102 | 1620 | 1885 | 1980 | 2195 |
| | H | 1450 | 1450 | 1520 | 1520 | 1520 | 1520 |
| Weight (kg) | | 70 | 70 | 120 | 130 | 140 | 160 |

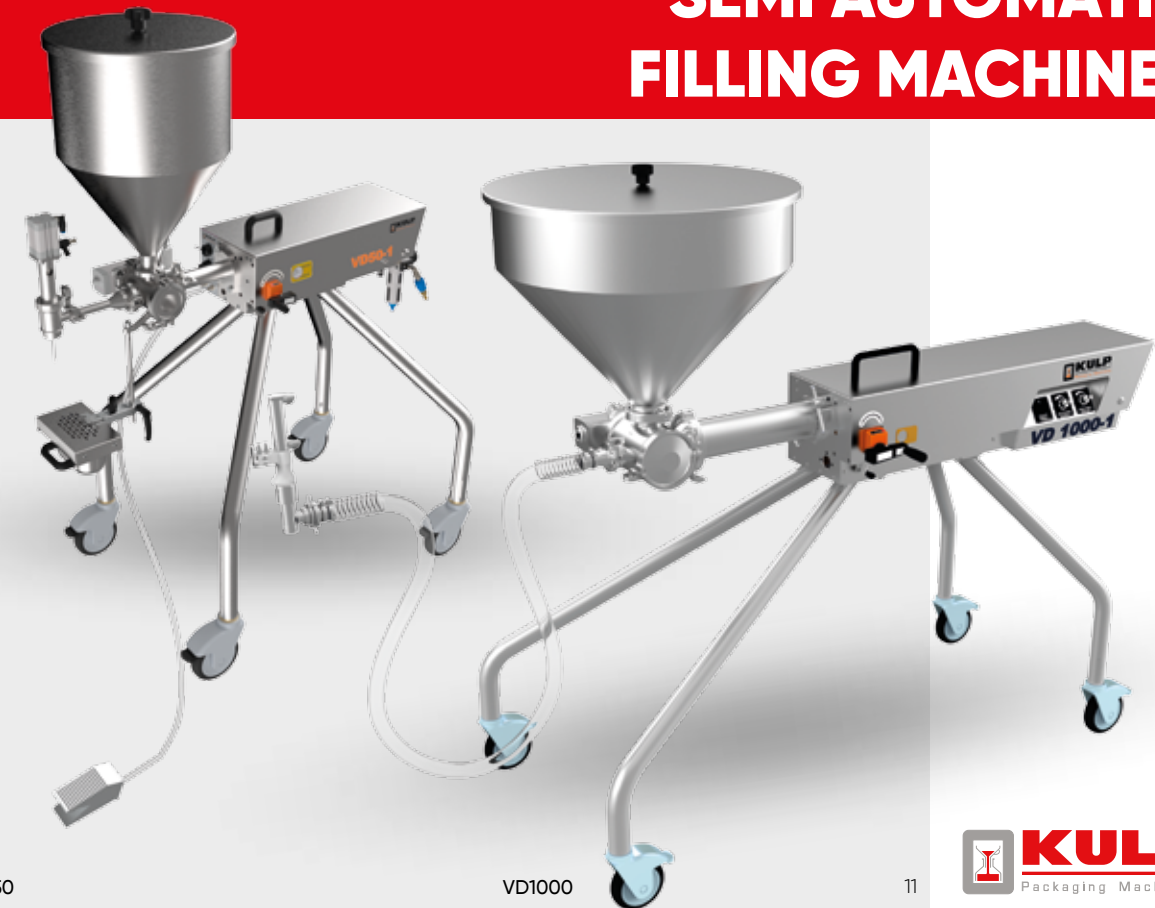

VD50

VD1000



ACCESSORIES

SEMI AUTOMATIC FILLING MACHINES

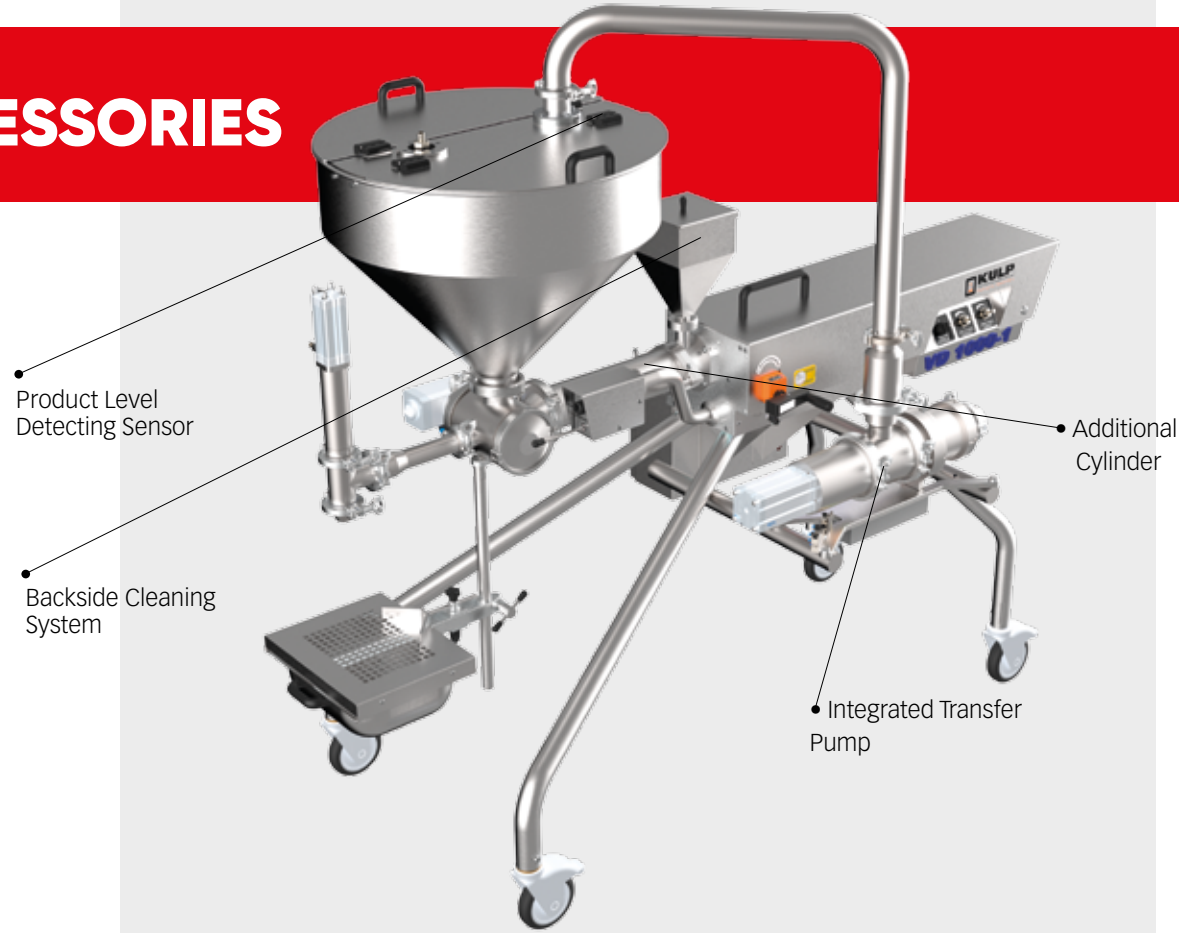



NOZZLES & ACCESSORIES

SEMI AUTOMATIC FILLING MACHINES

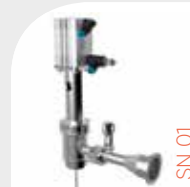

SN 01

Filling liquid & viscous products.



SN 02

Filling liquid & viscous products.



VNS 09

Filling viscous products with particles inside.

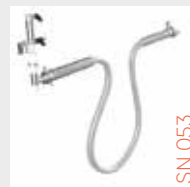

SN 053

Filling viscous products with particles inside.



SN 024

Filling yeast for diary products.

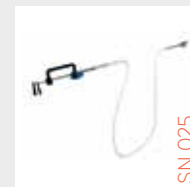

SN 025

Filling diary products.



AK 1032

Spout pouches filling.

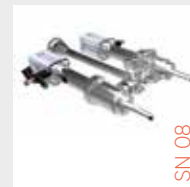

SN 08

Injection nozzle for bakery applications.



SN 093

Cake Filling Nozzle.



Double Jacketed Hopper

Keeps the products at a constant temperature during the filling process. Includes a thermostat to heat the water or heating oil between the jackets. The required temperature can be adjusted from the control panel. Water or heating oil can be used between the jackets.



Agitator

Keeps the products inside the hopper homogeneous, and in case of using the double jacketed hopper, it spreads the temperature equally around product. Can be easily installed on KULP fillers without need of any modification during the production or after sales.



Transfer Pumps



Product Level Detecting Sensor



Foot Pedal



Backside Cleaning System



Additional Filling cylinders

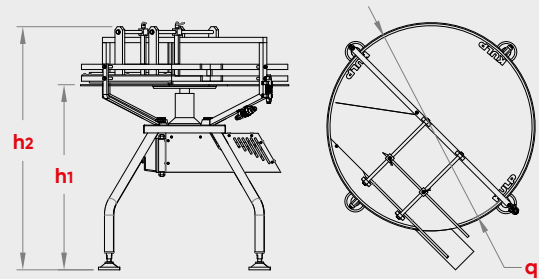

2

ACCUMULATION TABLES

- The feeding table dispatches the packages in a sequence into the conveyer systems, air rinsers or filling machines.
- The collecting table collects any shape of containers from the conveyer systems or filling lines.
- Ideal for jars, bottles, buckets or canisters in various sizes and shapes: hexagonal, square, oval.
- The diameter of the tables is either 980mm or 1200mm.
- The tables are placed on four legs. Height adjustment of the table can be made from the four legs separately.
- The height of the tables is 900 mm from the ground. (+/- 50 mm adjustable)
- The tables are made with 304 stainless steel.
- Stable or adjustable turning speed.

| Model | q | h ₁ | h ₂ |
|---------------|--------|----------------|----------------|
| BT980 | 980mm | 900mm | 1200mm |
| TT980 | 980mm | 900mm | 1000mm |
| BT1200 | 1200mm | 900mm | 1175mm |
| TT1200 | 1200mm | 900mm | 1000mm |



BT980



TT1200

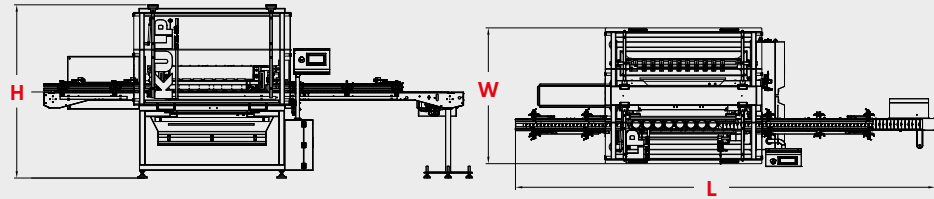

3

3

RINSERS

- KULP Rinsers is designed to clean the unwanted particulates from inside the packages that are made of glass, plastic or metal.
- Rotates the packages turn over and uses an air knife to remove the particulates.
- Uses the filtered air for creating the air spray that separates the dust or other particles from the inside surface of the jars and the bottles.
- Uses a FESTO filtration system or an air blower to clean the air to clean the air from the compressor.
- Offers high flexibility and simplicity for different dimensions of jars/bottles and can be easily integrated into any kind of packaging lines.
- The packages pass through the UV LIGHT tunnel for the sterilization before going to the filling unit.
- Touch Screen Control Panel.
- User friendly interface software in various languages.
- Heavy Duty Stainless Steel Frame.
- Lighted cabin with Polycarbon covers and security switches on doors.

| Model | Dimensions (mm) | | | Capacity Package/hour |
|-------------|-----------------|------|------|-----------------------|
| | W | H | L | |
| YIKYEL-550 | 1425 | 1780 | 2750 | 2400 |
| YIKYEL-1100 | 1420 | 1780 | 4400 | 4800 |



YIKYEL-1100

AUTOMATIC FILLING MACHINES

Filling Liquid, Viscous and Products with Particles

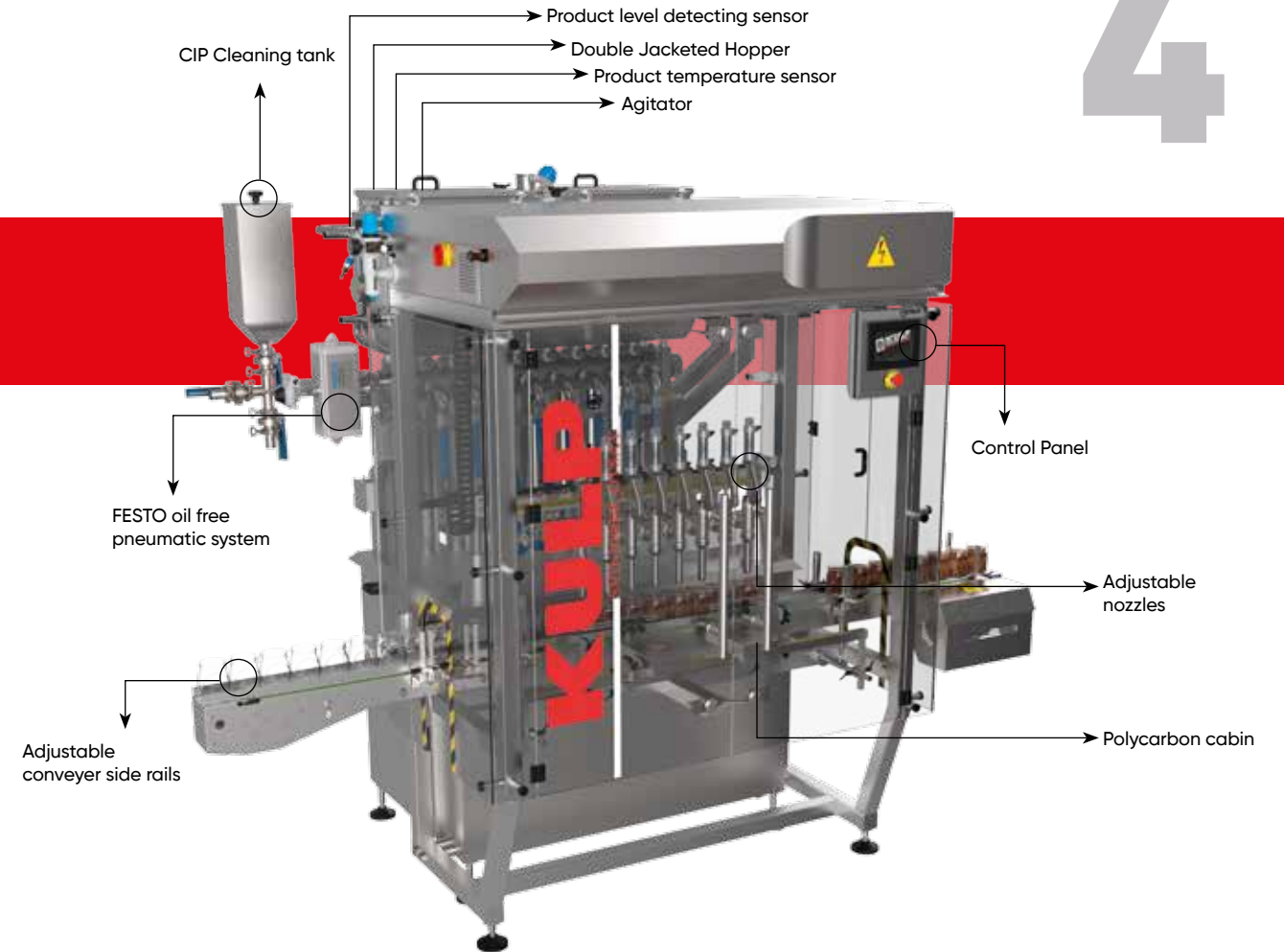

4

4

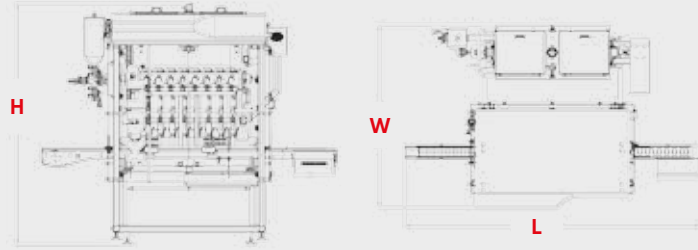

4

SERVO MOTOR

AUTOMATIC FILLING MACHINES

Filling Liquid, Viscous and Products with Particles

FESTO PNEUMATICS
OMRON HMI & PLC
OMRON SERVO MOTORS
SICK PHOTOCELLS

- Servo motor controlled filling cylinders and diving nozzles.
- Works with a 3 way control valve (PVD) that shuts off the product flow from the hopper, while opening it in another way, so that it allows viscous products and particles through the nozzles (up to 30 mm large).
- Another model (PDD) is available for liquid products only, works with a check valve that allows the product flow in one direction and automatically prevents it to come back.
- The volume adjustment can be done through the touch screen easily.
- Primes the product from a hopper with an automatic level control system.
- Interchangeable filling nozzles designed for liquids and viscous products, with an anti-dripping system.
- Bottom-up filling for foamy products with adjustable speed.
- Filling accuracy : $\pm 1\%$
- Suitable for hot and cold filling processes.
- The parts in contact with the product are inn 316L stainless steel.
- Lighted polycarbonate cabin with a security switch on the doors.
- Adjustable conveyer with side rails for various package sizes, shapes and materials.
- The working system is pneumatic and electronic. It operates with 6 bars compressed air.
- Optional additions:
 - C.I.P. suitable cleaning system.
 - Double Jacketed Hopper.
 - Agitator.
 - Filling Pistons' Back Side Cleaning System.

**For models list and capacities view page 24.*



SVD-1000-4_OTSA

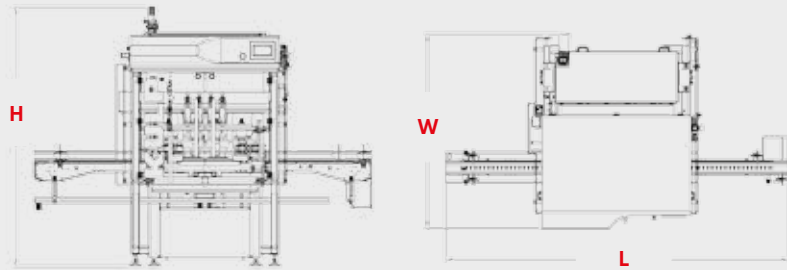

4

SERVO MOTOR

AUTOMATIC FILLING MACHINES

Filling Liquid, Viscous and Products with Particles

| Model | Filling Range (ml) (Min. - Max.) | | Number of Cylinders | Capacity** (Packages/ Hour) | Hopper volume (Lt.) | Dimensions (mm) | | |
|------------------------------------|-------------------------------------|------|------------------------|-----------------------------------|---------------------------|-----------------|------|------|
| | W | H | | | | L | | |
| SVD1000-4 OTSAY SDD1000-4 OTSAY | 100 | 1000 | 4 | 3000 | 100 | 2080 | 3000 | 2271 |
| SVD1000-6 OTSAY SDD1000-6 OTSAY | 100 | 1000 | 6 | 4500 | 130 | 2080 | 3000 | 2430 |
| SVD1000-8 OTSAY SDD1000-8 OTSAY | 100 | 1000 | 8 | 6000 | 180 | 1810 | 3000 | 2400 |
| SVD2000-4 OTSAY SDD2000-4 OTSAY | 200 | 2000 | 4 | 2600 | 100 | 2080 | 3000 | 2271 |
| SVD2000-6 OTSAY SDD2000-6 OTSAY | 200 | 2000 | 6 | 3900 | 130 | 2080 | 3000 | 2430 |
| SVD2000-8 OTSAY SDD2000-8 OTSAY | 200 | 2000 | 8 | 5200 | 180 | 1810 | 3000 | 2400 |
| SVD5000-4 OTSAY SDD5000-4 OTSAY | 1000 | 5000 | 4 | 2000 | 150 | 1680 | 3000 | 2235 |

** The filling capacity of the fillers can increase or decrease according to the physical specifications (viscosity, foaming, stickiness) of the product to be filled and the use diving nozzles (bottom to up filling). The filling capacities above are specified according to the maximum filling ranges.



SDD-5000-4_OTSA

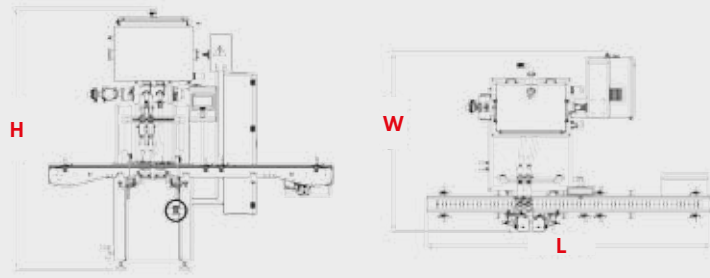

4

PNEUMATIC

For liquid, viscous and Products with particles

FESTO PNEUMATICS
OMRON HMI & PLC
SICK PHOTOCELLS

- Pneumatic controlled filling cylinders and diving nozzles.
- Works with a 3 way control valve (PVD) that shuts off the product flow from the hopper, while opening it in another way, so that it allows viscous products and particles through the nozzles (up to 30 mm large).
- Another model (PDD) is available for liquid products only, works with a check valve that allows the product flow in one direction and automatically prevents it to come back.
- The volume adjustment can be done through the touch screen easily.
- Primes the product from a hopper with an automatic level control system.
- Interchangeable filling nozzles designed for liquids and viscous products, with an anti-dripping system.
- Bottom-up filling for foamy products.
- Filling accuracy : $\pm 1\%$
- Suitable for hot and cold filling processes.
- The parts in contact with the product are inn 316L stainless steel.
- Lighted polycarbonate cabin with a security switch on the doors.
- Adjustable conveyer with side rails for various package sizes, shapes and materials.
- The working system is pneumatic and electronic. It operates with 6 bars compressed air.
- Optional additions:
 - C.I.P. suitable cleaning system.
 - Double Jacketed Hopper.
 - Agitator.
 - Filling Pistons' Back Side Cleaning System.

**For models list and capacities view page 28.*

AUTOMATIC FILLING MACHINES

4

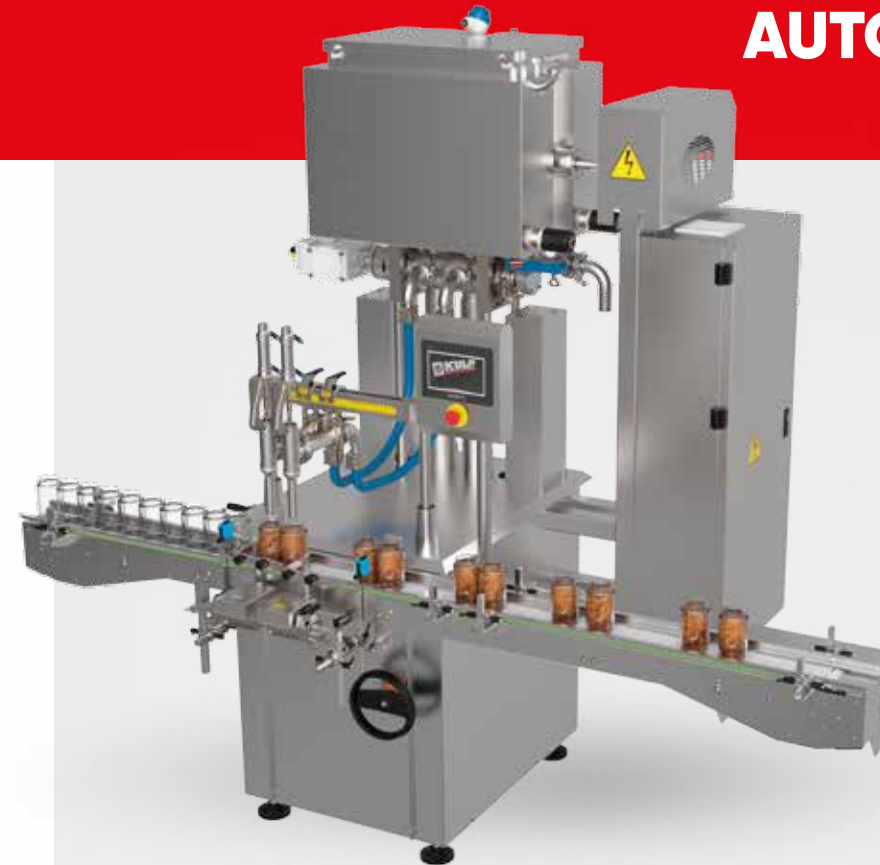

PVD-1000-2_OTPAY

PNEUMATIC

For liquid, viscous and Products with Particles

| Model | Filling Range (ml) (Min. / Max.) | | Number of Cylinders | Capacity** (Packages/ Hour) | Hopper volume (Lt.) | Dimensions (mm) | | |
|------------------------------------|-------------------------------------|------|------------------------|-----------------------------------|---------------------------|-----------------|------|------|
| | W | H | | | | L | | |
| PVD200-2 OTPAY PDD200-2 OTPAY | 5 | 200 | 2 | 1600 | 50 | 1200 | 1500 | 1700 |
| PVD200-4 OTPAY PDD200-4 OTPAY | 5 | 200 | 4 | 3200 | 50 | 1200 | 1500 | 1700 |
| PVD200-6 OTPAY PDD200-6 OTPAY | 5 | 200 | 6 | 4800 | 80 | 1200 | 2000 | 1700 |
| PVD200-8 OTPAY PDD200-8 OTPAY | 5 | 200 | 8 | 6000 | 80 | 1200 | 2000 | 1700 |
| PVD1000-2 OTPAY PDD1000-2 OTPAY | 100 | 1000 | 2 | 1500 | 100 | 1600 | 2500 | 2300 |
| PVD2000-2 OTPAY PDD2000-2 OTPAY | 200 | 2000 | 2 | 1200 | 100 | 1600 | 2500 | 2300 |
| PVD5000-2 OTPAY PDD5000-2 OTPAY | 1000 | 5000 | 2 | 840 | 100 | 1600 | 2500 | 2300 |

* The servo motor control can be included to these machines according to the customer's request.

** The filling capacity of the fillers can increase or decrease according to the physical specifications (viscosity, foaming, stickiness) of the product to be filled and the use diving nozzles (bottom to up filling). The filling capacities above are specified according to the maximum filling ranges.



AUTOMATIC FILLING MACHINES



PDD-200-8_OTA

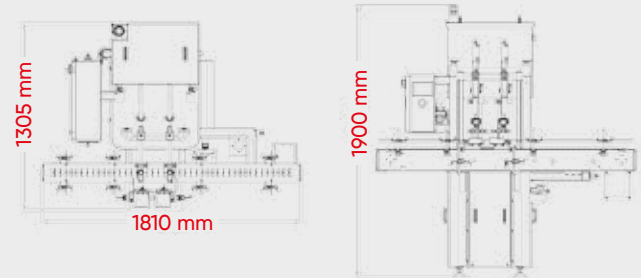

4

MECHANICAL

AUTOMATIC FILLING MACHINES

4

Filling Liquid & Viscous Products

FESTO PNEUMATICS
SICK PHOTOCELLS

- The filling pistons and diving nozzles are moved mechanically.
- The volume adjustment can be done through a wheel inside the machine.
- This model is available with two filling heads.
- The filling nozzles motion are diving constantly.
- Interchangeable filling nozzles designed for liquids and viscous products, with an anti-dripping system.
- Primes the product from a 100 liters hopper with an automatic level control system.
- Filling accuracy : $\pm 1\%$
- Suitable for hot and cold filling processes.
- Adjustable conveyer with side rails for various package sizes, shapes and materials.
- The machine works with cam system.
- Optional additions :
 - C.I.P. suitable cleaning system.
 - Double Jacketed Hopper.
 - Agitator.
 - Filling Pistons' Back Side Cleaning System.



CAPACITY
1400 PACKAGE/HOUR
Min : 100ml - Max : 1000ml

TWO COMPONENT FILLING MACHINES

FESTO PNEUMATICS
OMRON HMI & PLC
SICK PHOTOCELLS

Examples: Vinegar and Oil,
Sauce and Oil, Balsamic and
Oil, Lemon Juice and Oil,
Yogurt and Jam, etc.



- These machines are designed to fill two different products into a single package in a constant ratio.
- Includes two separate filling systems for each component with separate filling adjustments.
- The volume adjustment can be done by a hand wheel and a numerator on the machine.
- Interchangeable filling nozzles designed for liquids and viscous products, with an anti-dripping system.
- Bottom-up filling for foamy products.
- Filling accuracy : $\pm 1\%$
- Suitable for hot and cold filling processes.
- The parts in contact with the product are inn 316L stainless steel.
- Adjustable conveyer with side rails for various package sizes, shapes and materials.
- The working system is pneumatic and electronic. It operates with 6 bars compressed air.

| Model | First Product | Second Product | Capacity** (Packages/ Hour) | Dimensions (mm) | | |
|----------------------------|-------------------------------------|-------------------------------------|-----------------------------------|-----------------|------|------|
| | Filling Range (ml) (Min. - Max.) | Filling Range (ml) (Min. - Max.) | | W | H | L |
| VD50-4 FOT / VD10-4 FOT | 5ml - 50 ml | 2ml - 10 ml | 4000 | 1300 | 3000 | 2200 |
| VD500-6 OT / VD150-6 OT | 50ml - 500ml | 15ml - 150ml | 3000 | 1500 | 3000 | 2200 |
| PDD200-8 OTA / PDD50-8 OTA | 20ml - 200ml | 5ml - 50ml | 4800 | 1500 | 4000 | 1700 |

* The servo motor control can be included to these machines according to the customer's request.

** The filling capacity of the fillers can increase or decrease according to the physical specifications (viscosity, foaming, stickiness) of the product to be filled and the use diving nozzles (bottom to up filling). The filling capacities above are specified according to the maximum filling ranges.

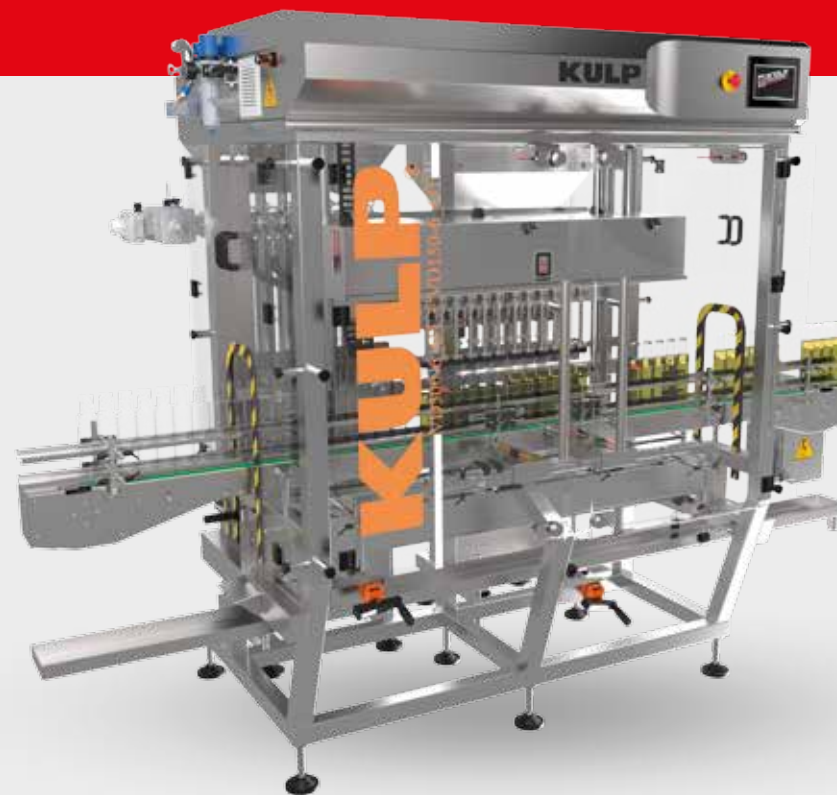

VD500-6_OT+VD150-6_OT

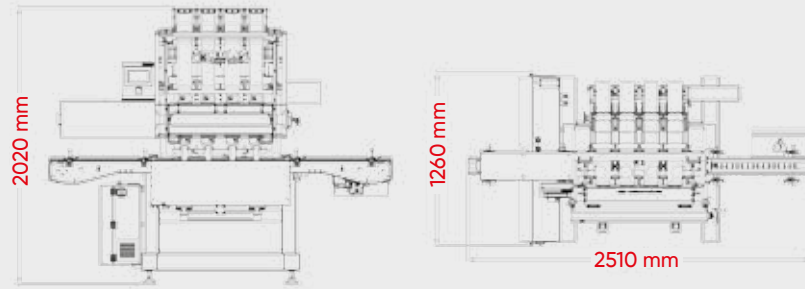

5

CAPLESS SEALING

FESTO PNEUMATICS
OMRON HMI & PLC
OMRON SERVO MOTORS
SICK PHOTOCELLS

- Uses the liner (foil) from the roll to cut and seal it on the jar/bottle automatically.
- The liner adjustment can be done through the touch screen according to the diameter of the jar/ bottle neck.
- There are multiple sealing heads working separately synchronized with each other.
- Easy to change liner rolls.
- Lighted cabin with 10mm polycarbon covers and security switches on the doors.
- No container-No Seal System.
- User friendly touch screen interface available in different languages.
- 3 meters conveyer with adjustable side rails for various sizes of packages.
- The working system is pneumatic and electronic. It operates with 6 bars compressed air.
- The consumption of air is 800 lt/minute when it's performing with the maximum volume and the maximum speed.
- The electrical connection is three phase (380v / 50-60 Hz)
- Touch Screen Control Panel.
- User friendly interface software in various languages.
- Recordable programming on the memory.
- Heavy Duty Stainless Steel Frame.

SEALING MACHINES



SEALING-105-4

CAPACITY
4800 PACKAGE/HOUR

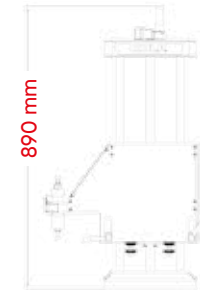
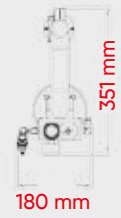
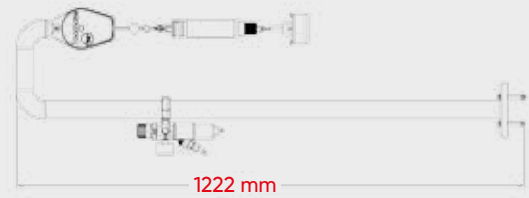

SEMI AUTOMATIC CAPPING MACHINES

- Portable hand held capping system which is capable of tightening Plastic & Metal Screw Caps and Metal Twist-Off Caps.
- It can be adapted to different cap sizes by changing the mold.
- Functions with a pneumatic system.
- Takes its motion from an air motor.
- Has a plastic mold to prevent the caps from being damaged because of friction.
- Torque adjustment is done via compressed air inlet.
- Automatically functions when pressed on the cap.
- Automatically stops when reaching the desired torque for the cap.
- The Balancer on the system makes the machine weightless and easy to operate while changing from one package to another.
- Easily installed on working tables or conveyor lines.
- Works for the standard and special sizes of caps.

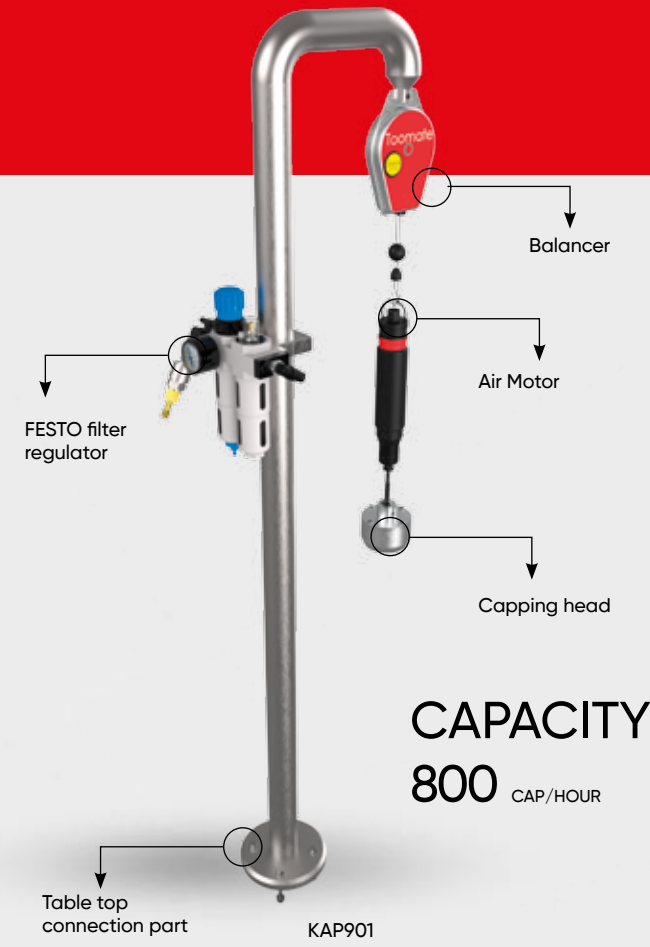

CAPACITY
800 CAP/HOUR



CAPACITY
800 CAP/HOUR

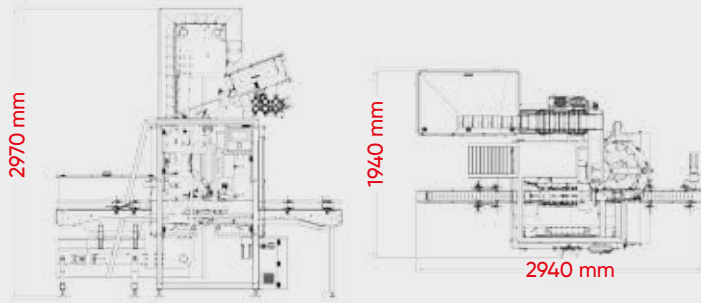

6

KAP 936

AUTOMATIC CAPPING MACHINES

FESTO PNEUMATICS
OMRON HMI & PLC
SICK PHOTOCELLS

- This one head capping machine is capable of closing several types and sizes of caps.
- It includes an integrated cap elevator to feed the caps to the cap sorting system continuously.
- The sorting system is a mechanical sorter that distributes the caps to the cap chute and dispensing blade in the correct position.
- A single capping head is driven by a step motor with an adjustable capping torque.
- The capping head has a special plastic mold to prevent cap damages caused by friction.
- All the mechanical adjustments according to the height of the packages (sorter, cap chute and dispensing blade) are done by the help of the hand wheel and the numerator.
- Superior stability of the containers during the cap tightening process thanks to the belt system, especially for high and soft containers.
- The conveyer's speed and side rails can be easily adjusted according to the width of the packages.
- Suitable cap types:

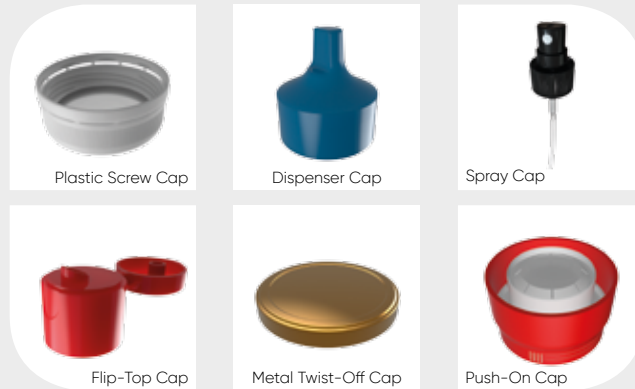

CAPACITY
3000 CAP / HOUR

6

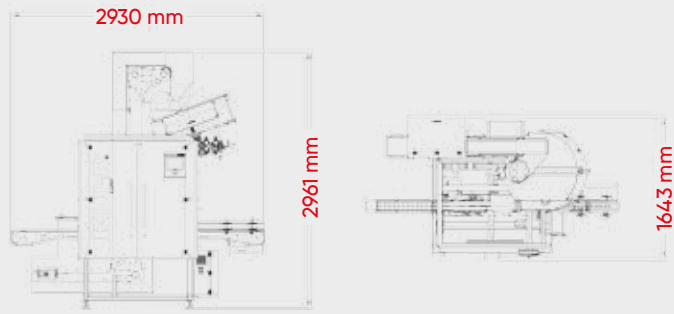

6

KAP 937

AUTOMATIC CAPPING MACHINES

FESTO PNEUMATICS
OMRON HMI & PLC
SICK PHOTOCELLS

- This multiple heads capping machine is capable of closing several types and sizes of caps.
- It includes an integrated cap elevator to feed the caps to the cap sorting system continuously.
- The sorting system is a mechanical sorter that distributes the caps to the cap chute and dispensing blade in the correct position.
- several capping heads are driven by a step motor with an adjustable capping torque.
- The capping heads have a special plastic mold to prevent cap damages caused by friction.
- All the mechanical adjustments according to the height of the packages (sorter, cap chute and dispensing blade) are done by the help of the hand wheel and the numerator.
- Superior stability of the containers during the cap tightening process thanks to the belt system, especially for high and soft containers.
- The conveyer's speed and side rails can be easily adjusted according to the width of the packages.
- Suitable cap types:

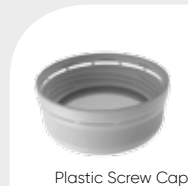

Plastic Screw Cap



Push-Pull Cap

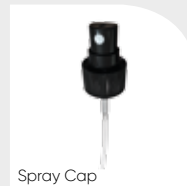

Spray Cap



Flip-Top Cap



Metal Twist-Off Cap



Push-On Cap

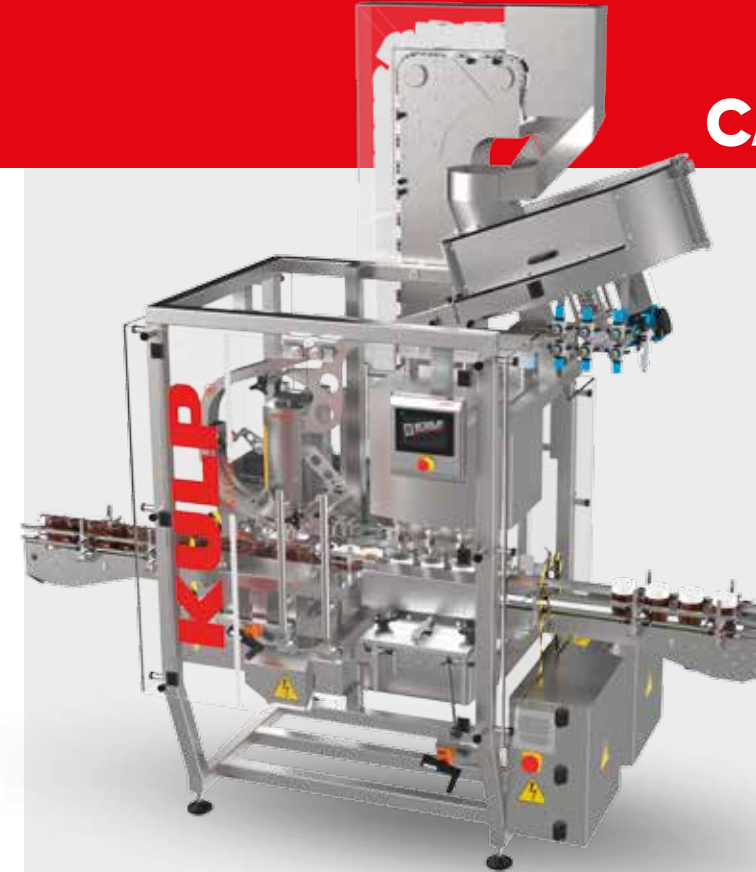

KAP 937

CAPACITY
4800 CAP / HOUR

6

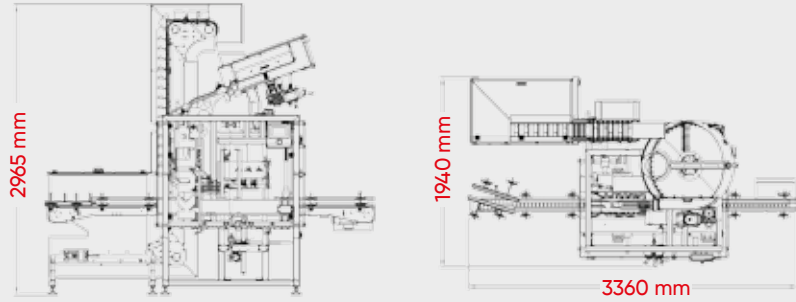

6

KAP 938

AUTOMATIC CAPPING MACHINES

FESTO PNEUMATICS
OMRON HMI & PLC
SICK PHOTOCELLS

- The machine does not stop the containers during the capping process (Continuous Inline Capping System).
- It includes an integrated cap elevator to feed the caps to the cap sorting system continuously.
- The sorting system is a mechanical sorter that distributes the caps to the cap chute and dispensing blade in the correct position, before passing through the discs.
- Six discs are driven by a motor with an adjustable capping torque.
- All the mechanical adjustments according to the height of the packages (sorter, cap chute and dispensing blade) are done by the help of the hand wheel and the numerator.
- Superior stability of the containers during the cap tightening process thanks to the belt system, especially for high and soft containers.
- The conveyer's speed and side rails can be easily adjusted according to the width of the packages.
- Suitable cap types:

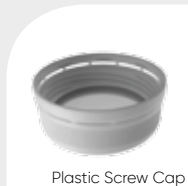

Plastic Screw Cap



Squeeze Cap



Trigger Cap

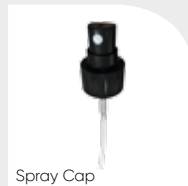

Spray Cap



Flip-Top Cap



Metal Twist-Off Cap



Pump Cap



Push-On Cap

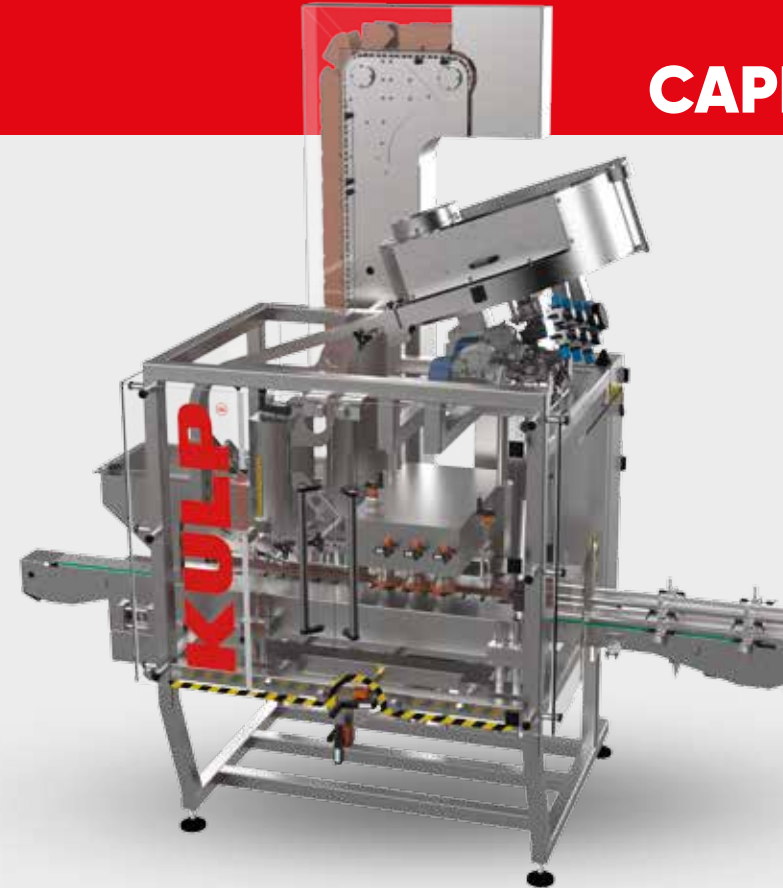

KAP 938

CAPACITY
6000 CAP / HOUR

6

KAP 932

FESTO PNEUMATICS
OMRON HMI & PLC
SICK PHOTOCELLS

- A compact solution which is capable of closing lids for plastic buckets or metal tin cans.
- The lids are distributed on the buckets automatically by the lid sorting system, then automatically squeezed by the 8 rollers.
- The machine has 8 stainless steel rollers to squeeze the lids on the plastic buckets.
- The rollers are placed with a desired angle to squeeze the lids evenly.
- It has a height adjustable mechanism with the hand wheel and numerator to adjust the system according to the different height of buckets.
- The conveyer side rails can be easily adjusted according to the width of the buckets.
- 3 meter speed adjustable conveyor line.
- Easy change over for different sizes of lids.
- Torque adjustment is made by the compressed air inlet.
- Works with 380 volts / 50-60 Hz electrical power.
- Suitable cap types:

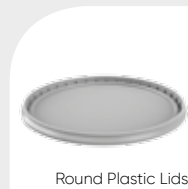

Round Plastic Lids



Rectangular Plastic Lids

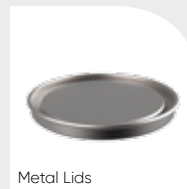

Metal Lids

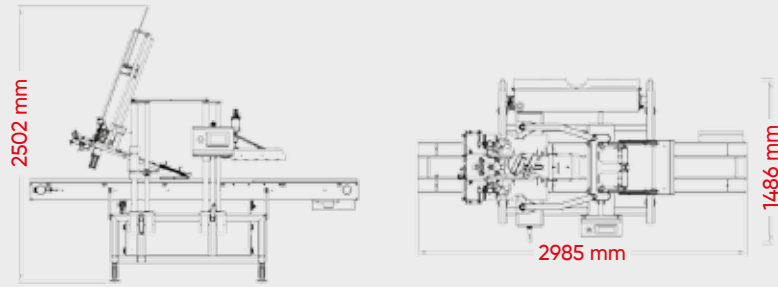

6

AUTOMATIC CAPPING MACHINES



CAPACITY
1800 CAP / HOUR

6

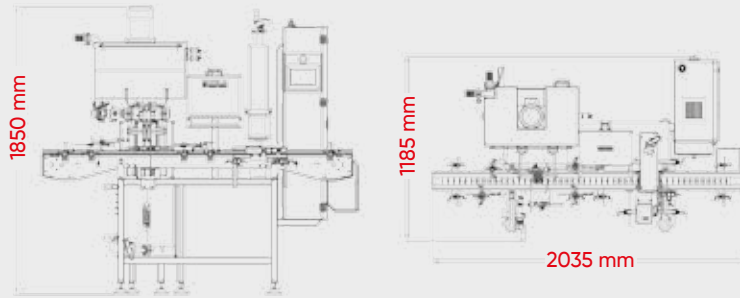

7

FILLING & CAPPING

MONOBLOCK MACHINES

Manual Placing of the Caps, Automatic Capping

FESTO PNEUMATICS
OMRON HMI & PLC
SICK PHOTOCELLS

Options:
C.I.P. suitable cleaning system.
Double Jacketed Hopper.
Agitator
Optional Filling Piston Back
Side Cleaning System.etc.

- Volumetric filling unit and one capping unit within the same frame, reducing the cost and the size of the machine.
- Two interchangeable filling nozzles designed for liquids and viscous products, with an anti-dripping system.
- The caps are placed manually and automatically closed by the capping system with the required torque.
- The volume adjustment can be done by a hand wheel and a numerator on the machine.
- Primes the product from a hopper with an automatic level control system.
- Bottom-up filling for foamy products.
- The working system is pneumatic or electronic. It operates with 6 bars compressed air.
- The capping head can be changed easily according to different types and sizes of caps.
- Ideal for twist-off caps, plastic screw caps, push-on caps another model is available for plastic and metal lids on buckets.
- Adjustable conveyor with side rails for various package sizes, shapes and materials.

| Model | Filling Range (ml) | | Capacity** Unit/Hour | Dimensions (mm) | | | Working mode |
|------------------|--------------------|--------|-------------------------|-----------------|------|------|--------------|
| | Min. | Max. | | W | H | L | |
| PVD200-2 FOTPAY | 5ml | 200ml | 1600 | 1200 | 2000 | 1850 | Pneumatic |
| PVD1000-2 FOTPAY | 100ml | 1000ml | 1500 | 1600 | 2500 | 2300 | Pneumatic |
| KDD1000-2 FOTPAY | 100ml | 1000ml | 1500 | 1400 | 1800 | 1900 | Mechanical |
| PVD2000-2 FOTPAY | 200ml | 2000ml | 1200 | 1800 | 4000 | 2300 | Pneumatic |
| PVD5000-2 FOTPAY | 1000ml | 5000ml | 840 | 1600 | 2500 | 2300 | Pneumatic |

** The filling capacities above are specified according to the maximum filling ranges.



PVD-1000-2_FOTPAY

PVD-2000-2_FOTPAY



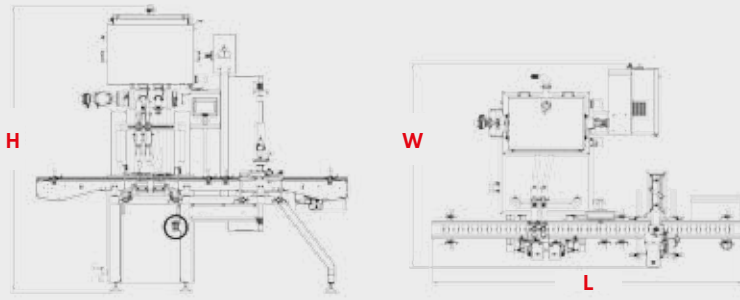

7

FILLING & CAPPING

MONOBLOCK MACHINES

Automatic Sorting, Placing and Capping

FESTO PNEUMATICS
OMRON HMI & PLC
SICK PHOTOCELLS

Options:
C.I.P. suitable cleaning system.
Double Jacketed Hopper.
Agitator
Optional Filling Piston Back
Side Cleaning System.etc.

- Consist of one volumetric filling unit and one capping unit within the same frame, reducing the cost and the size of the machine.
- Four or Six interchangeable filling nozzles designed for liquids and viscous products, with an anti-dripping system.
- The caps are delivered to the sorting system by the cap elevator.
- The sorting system distributes the caps to the cap chute and dispensing blade in the correct position.
- The caps are automatically placed on the packages and closed by the capping system with the required torque.
- The capping head can be changed easily according to different types and sizes of caps.
- The volume adjustment can be done by a hand wheel and a numerator on the machine.
- The level control system is synchronized with the transfer pump to start or stop.
- Bottom-up filling for foamy products.
- The working system is pneumatic an electronic. It operates with 6 bars compressed air.
- Ideal for twist-off caps, plastic screw caps, push-on caps
- Adjustable conveyer with side rails for various package sizes, shapes and materials.

| Model | Filling Range (ml) | | Capacity** Unit/Hour | Dimensions (mm) | | | Working mode |
|------------------|--------------------|--------|-------------------------|-----------------|------|------|--------------|
| | Min. | Max. | | W | H | L | |
| PVD200-4 FOTPAY | 5ml | 200ml | 4000 | 1500 | 3000 | 2100 | Pneumatic |
| PVD500-6 FOTPAY | 100ml | 1000ml | 3000 | 1400 | 3000 | 2100 | Pneumatic |
| SVD1000-6 FOTPAY | 100ml | 1000ml | 3900 | 1500 | 5500 | 3000 | Servo Motor |

** The filling capacities above are specified according to the maximum filling ranges.



PVD-500-6_FOTSA



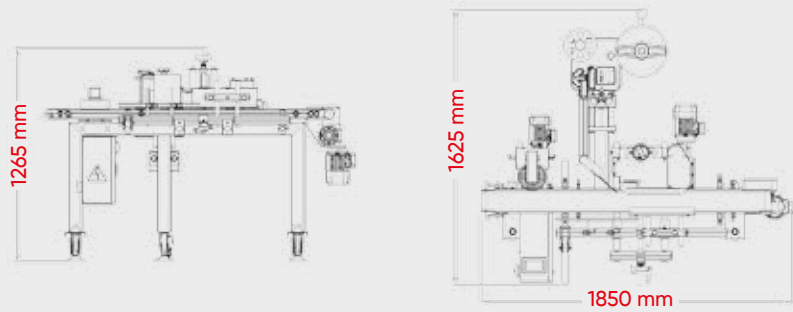

8

E-11 LABELING MACHINES

One Side / Wrap-Around Labeling Machine

- For jar, bottles and canisters.
- Uses self-adhesive labels.
- Either cylindrical (round), hexagonal or square shapes.
- ± 0.5mm labeling accuracy.
- Touch Screen control panel.
- User friendly interface software in several languages.
- Flexibility for a wide range of containers for now and in the future.
- Heavy duty stainless steel frame.
- Easy adjustments by hand wheels and numerators.
- Can dispense labels for max 100 in width (optional label dispensers for max 300mm).
- Stepper motor controlled label dispensers.
- Specific photocells for transparent labels.
- Optional angle adjustment device for conical packages.
- Optional hot-foil printers.

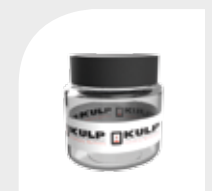

Round / Oval
Wrap-Around Labeling

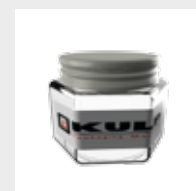

Hexagonal/Square
Wrap-Around Labeling



One Side Labeling



CAPACITY
3000 PACKAGE/HOUR

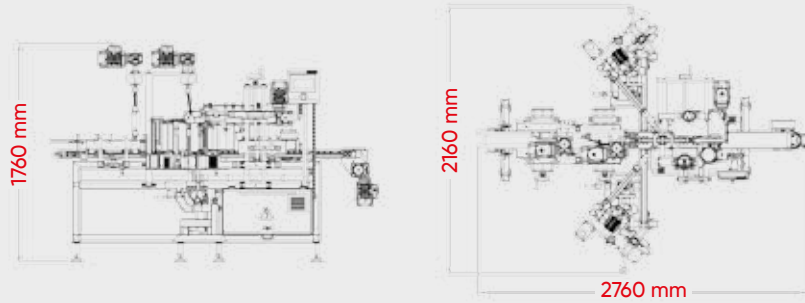

8

E-40

LABELING MACHINES

Front & Backside Labeling Machine

- For jar and bottles.
- Uses self-adhesive labels.
- Either ellipse, oval, rectangle or square shapes.
- $\pm 0.5\text{mm}$ labeling accuracy.
- Touch Screen control panel.
- User friendly interface software in several languages.
- Flexibility for a wide range of containers for now and in the future.
- Heavy duty stainless steel frame.
- Easy adjustments by hand wheels and numerators.
- Can dispense labels for max 100 in width (optional label dispensers for max 300mm).
- Stepper motor controlled label dispensers.
- Specific photocells for transparent labels.
- Optional angle adjustment device for conical packages.
- Optional hot-foil printers.

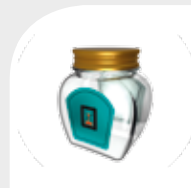

One/Double Sided Labeling

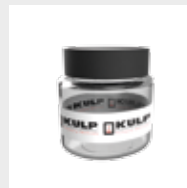

Round / Oval Wrap-Around Labeling

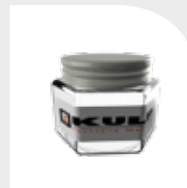

Hexagonal/Square Wrap-Around Labeling



CAPACITY
4800 PACKAGE/HOUR

E-40

53



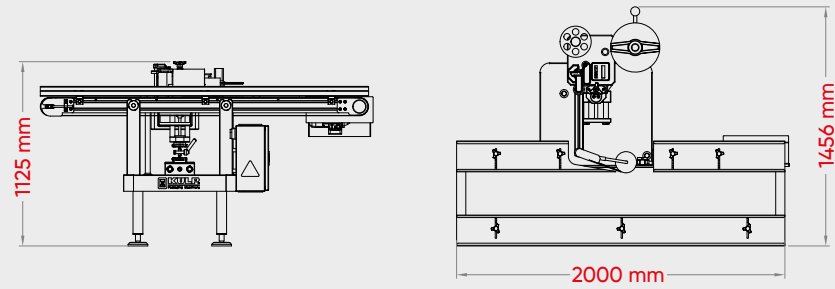

8

E-50

LABELING MACHINES

Bucket Labeling Machine

- For buckets and canisters
- Uses self-adhesive labels.
- $\pm 0.5\text{mm}$ labeling accuracy.
- Touch Screen control panel.
- User friendly interface software in several languages.
- Flexibility for a wide range of containers for now and in the future.
- Heavy duty stainless steel frame.
- Easy adjustments by hand wheels and numerators.
- Can dispense labels for max 100 in width (optional label dispensers for max 300mm).
- Stepper motor controlled label dispensers.
- Specific photocells for transparent labels.
- Optional angle adjustment device for conical packages.
- Optional hot-foil printers.



One side /top side labeling



One Side Labeling



CAPACITY
1500 PACKAGE/HOUR

E-50

55

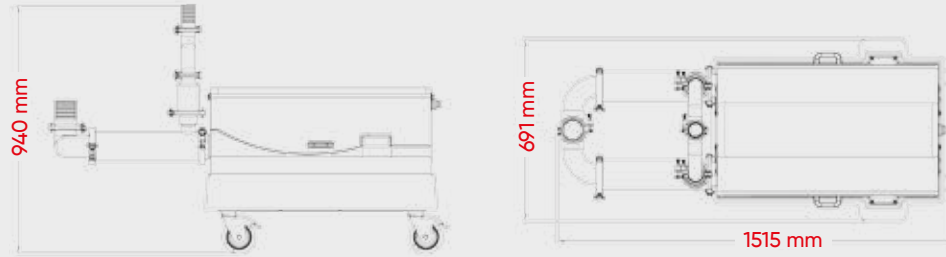

9

TRANSFER PUMPS

For Liquid Products

- The pumps can be used to transfer liquid, viscous and products with particles from the storage tank/mixer to the filling machine, or from the production tank to the storage tank.
- Work with electricity (380 Volts- 50-60 Hz)
- The volumetric piston system doesn't crush the product transferred.
- High surface smoothness and argon arc welding technology prevents contamination.
- The seals are manufactured from teflon, viton or polyethylene according to the product to be transferred.
- The parts that contact with the product are 316 L stainless steel. The other parts are 304 L stainless steel and anodized aluminum.



56

PD100_2

For Viscous and Products with Particles

CAPACITY
3500 LITER/HOUR



PV100_2

57

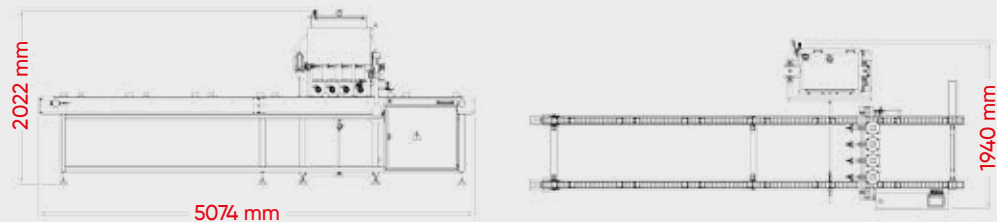

10

PDD-1000-4_OTA

SPECIAL DESIGNS

Bakery Filling Machine

FESTO PNEUMATICS
OMRON HMI & PLC
SICK PHOTOCELLS

- Special machine to fill cheese cakes, cake doughs, liquid or viscous toppings, creams and other bakery products.
- The volume adjustment can be done by a hand wheel and a numerator on the machine.
- Primes the product from a 100 liters hopper with an automatic level control system.
- Four interchangeable filling nozzles designed for liquids and viscous products, with an anti-dripping system.
- Bottom-up filling for foamy products with adjustable speed.
- Filling accuracy : $\pm 1\%$
- Suitable for hot and cold filling processes.
- The parts in contact with the product are inn 316L stainless steel.
- Adjustable conveyer with side rails for various mold sizes, shapes and materials.
- The working system is pneumatic and electronic. It operates with 6 bars compressed air.
- Suitable for different size of trays.

Options:

- C.I.P. suitable cleaning system.
- Double Jacketed Hopper.
- Agitator.



CAPACITY
3000 MOLD/HOUR
Min : 100ml - Max :1000ml

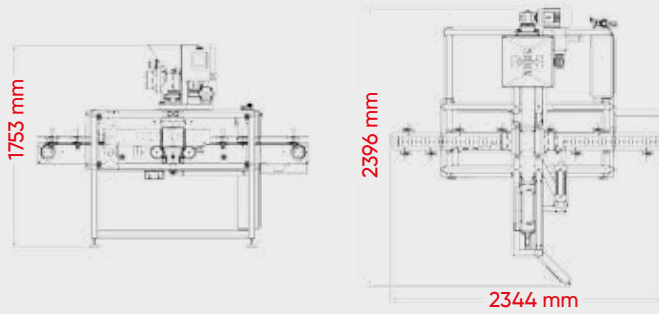

10

BVD-500-1_OT

SPECIAL MACHINES

Paste Filling Machine

FESTO PNEUMATICS
OMRON HMI & PLC
SICK PHOTOCELLS

Examples: Date Paste, Nuts Paste, Dried Fruit Paste, Etc.

- Feeds the pasty products to the filling cylinder by the help of the in-feed screw.
- All the parts including the main valve and the nozzles are connected by tri-clamps for an easy disassembling for the cleaning process.
- The volume adjustment can be done by a hand wheel and a numerator on the machine.
- Primes the product from a 30 liters hopper with an automatic level control system.
- Suitable for hot and cold filling processes.
- Adjustable conveyer with side rails for various package sizes, shapes and materials.
- No container-No fill System.
- User friendly touch screen interface available in different languages.
- 2 meters conveyer with adjustable side rails for various sizes of packages.
- The working system is pneumatic an electronic. It operates with 6 bars compressed air.
- The consumption of air is 800 lt/minute when it's performing with the maximum volume and the maximum speed.
- The electrical connection is three phase (380v / 50-60 Hz)
- An agitator is included into the hopper.



CAPACITY
900 PACKAGE/HOUR
Min : 50ml - Max :500ml

BVD-500-1_OT

Medium Capacity Line

FILLING LINES

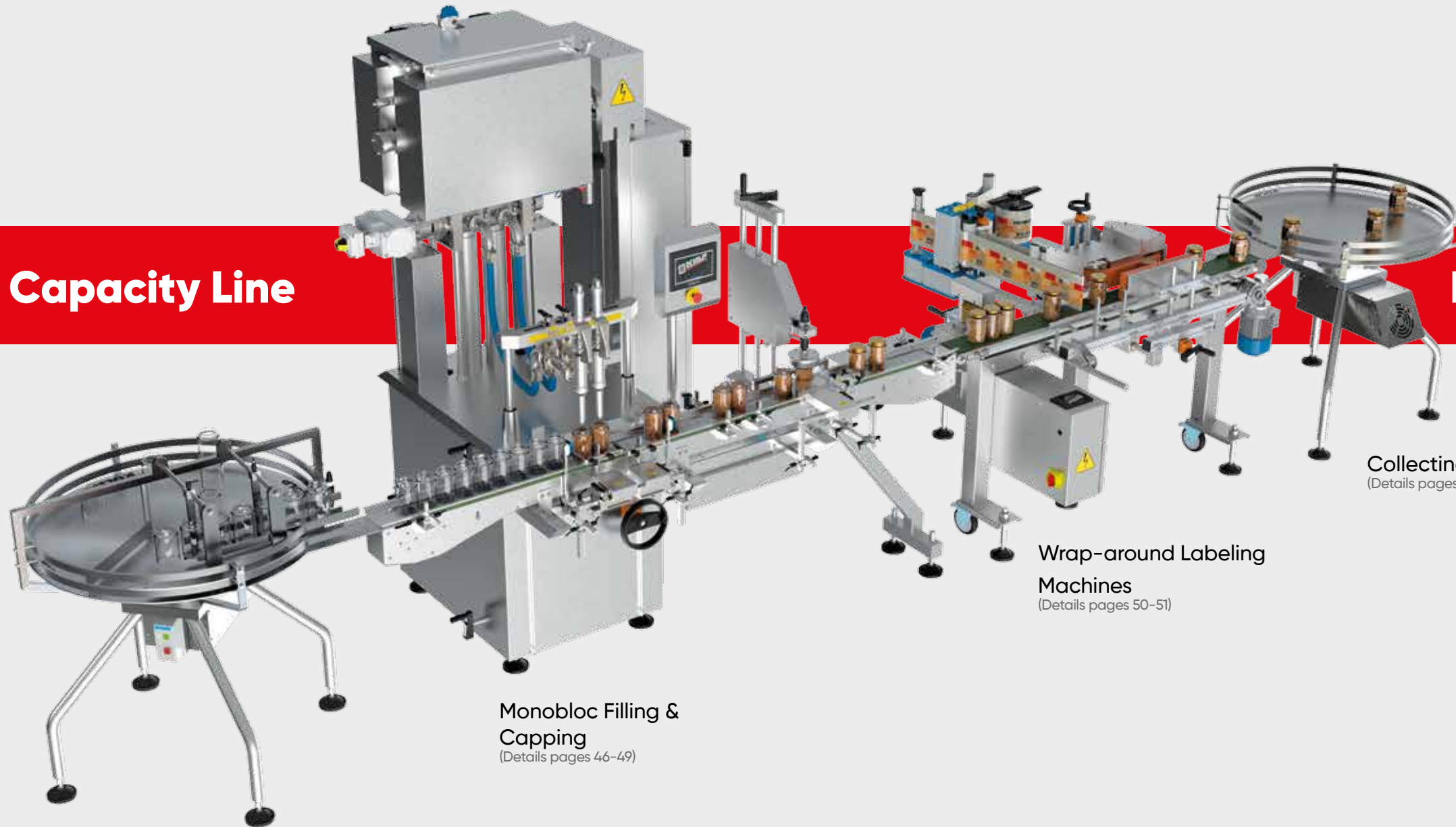

Feeding Tables
(Details pages 16-17)

Monobloc Filling &
Capping
(Details pages 46-49)

Wrap-around Labeling
Machines
(Details pages 50-51)

Collecting Tables
(Details pages 16-17)

High Capacity Line

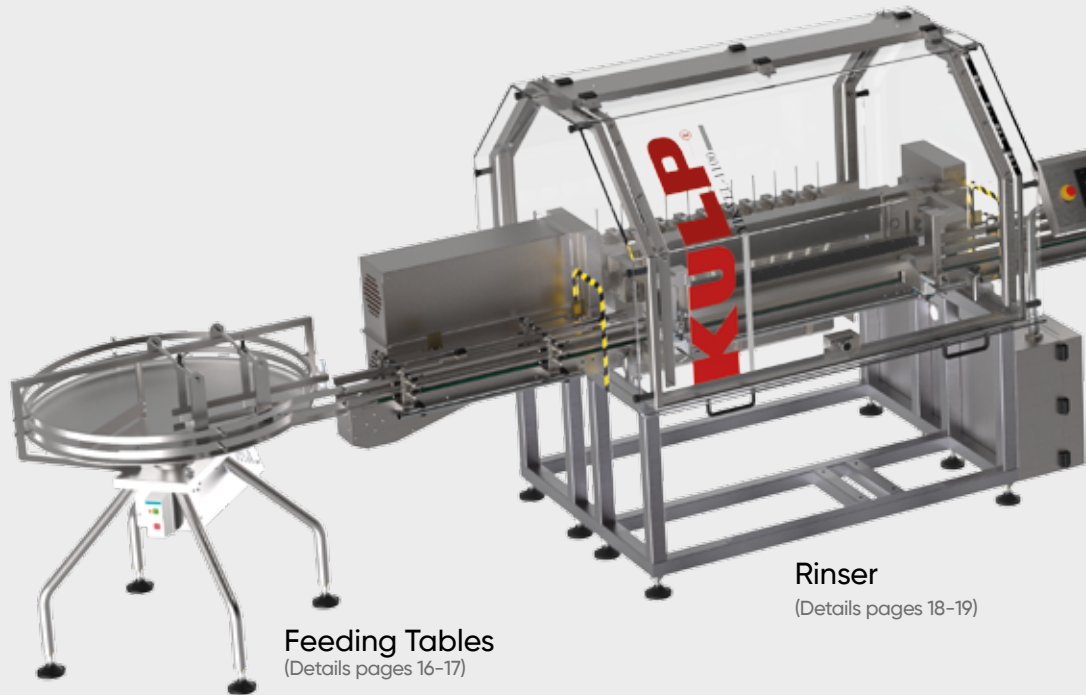

Feeding Tables
(Details pages 16-17)

Rinser
(Details pages 18-19)

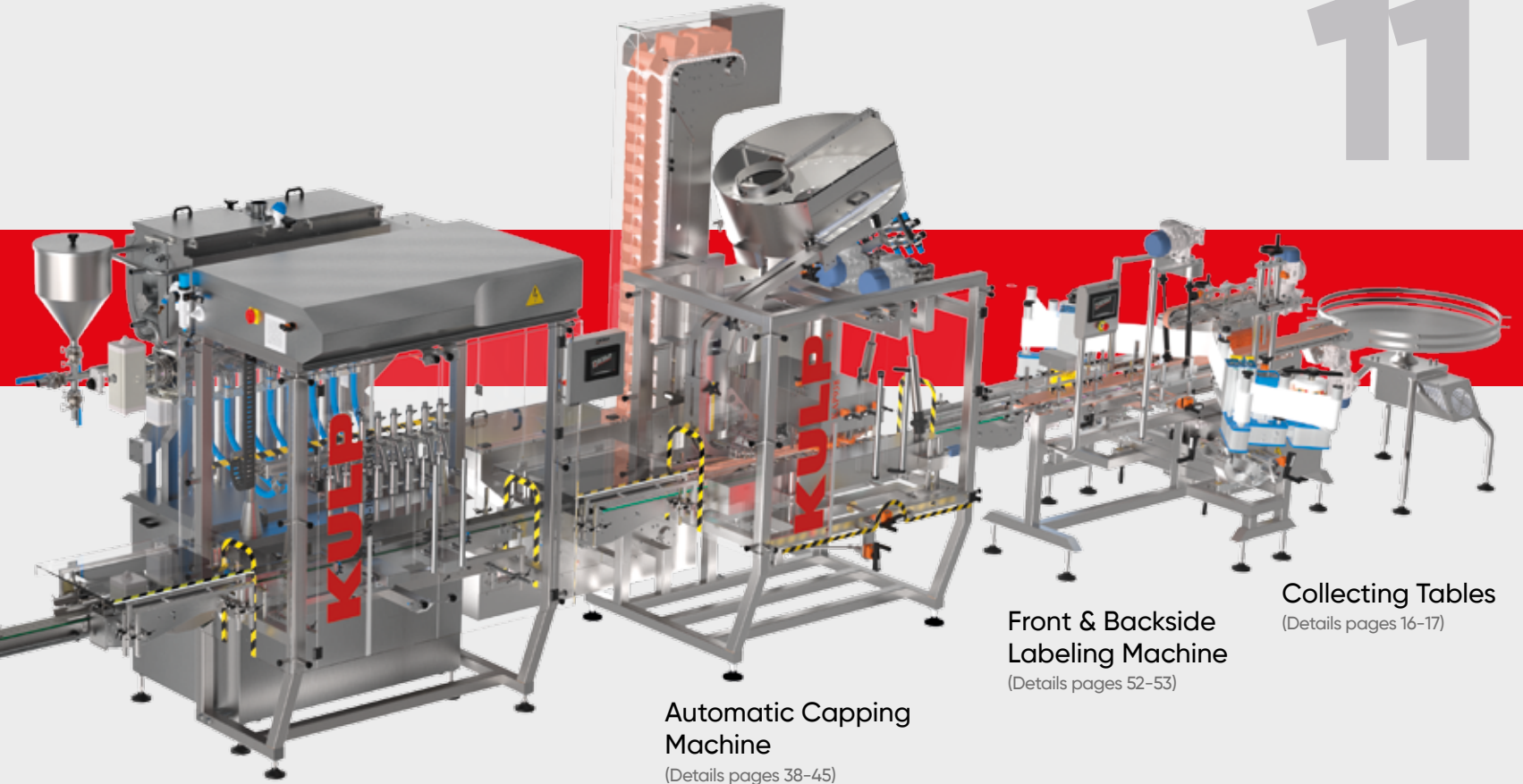

Automatic Servo Motor
Controlled Filling Machine
(Details pages 22-25)

Automatic Capping
Machine
(Details pages 38-45)

Front & Backside
Labeling Machine
(Details pages 52-53)

Collecting Tables
(Details pages 16-17)

Line for Buckets & Canisters



Feeding Tables
(Details pages 16-17)

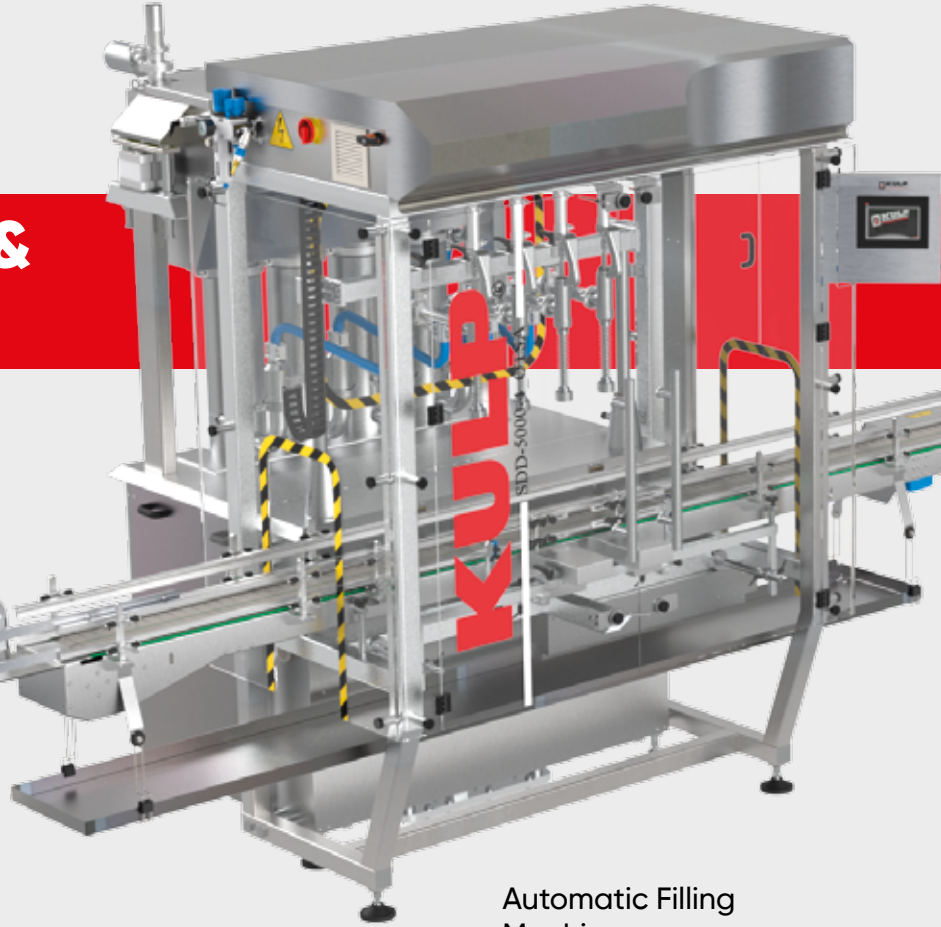

Automatic Filling Machine
(Details pages 20-33)



Bucket Capping Machine
(Details pages 44-45)



Top & Sides Labeling Machine
(Details pages 54-55)

Collecting Tables
(Details pages 16-17)

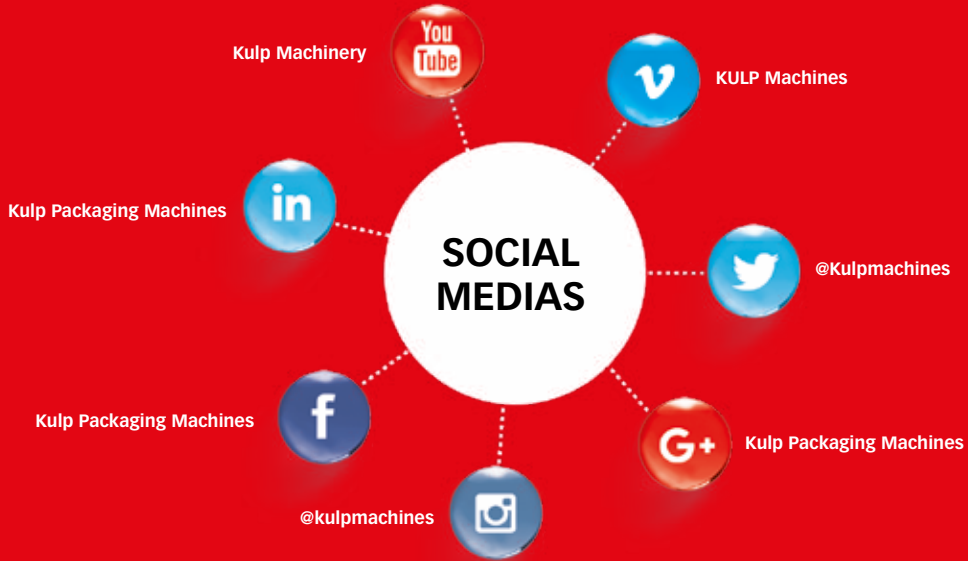

Çavuşbaşı Caddesi No:56-A Çekmeköy
34782 İstanbul - Türkiye
T: +90 (216) 641 21 83 - +90 (216) 641 21 84
info@kulp.com.tr - www.kulp.com.tr



E00012019T